

In the field of architectural fittings for aluminum & tempered glass doors. both high quality and total design flexibility are essential criteria together with ease of installation, safety and function.

GCC full range of fittings are aesthetically designed and manufactured to provide practicality and security to tempered glass assemblies, such as Tempered Glass Door Fittings, PVC Seals W/Weather Strips, Glass Clamps, Shower Door Hinges, Handles & Knobs, PVC Seals & Wipes and Reinforcement Bars for Shower Screen. Door Rails, Pivoting Door systems, office partition systems, Lever Hinges & Locks, Heavy-Duty Sliding Wall systems, Floor Spring, Concealed Overhead Door Closer, Glass Connectors....etc. For details welcome to visit our website at www.gccintw.com.tw

GCC will be happy to help your special requirements, for any doubts, please contact your nearest **GCC** distributors for any technical assistance on parts and services, or contact us directly.

If you are looking for high quality products, **GCC** is your best choice.



● Separate glass notching details are available upon request

Agent/ Distributor



GOOD CREDIT CORPORATION

No.13, Longmen Rd., Situn Dist., Taichung 40757, Taiwan

TEL: 886-4-22583755(Hunting Line)

FAX: 886-4-22583753

E-mail: gcctw@ms7.hinet.net

<http://www.gccintw.com.tw>



© Copyright 2010.07 Good Credit Corporation

GCC[®]

Tempered Glass Fittings



Installation Dimensions

X: 7-10mm Y: 2-4mm Z: 3-5mm

GT/GP Series

Max. door weight: 90Kgs.

Max. door width: 1200mm

If door panel 3M high by 1M wide, using 12mm thick glass is quite possible.

For door weight up to 120Kgs and width up to 1400mm, Door Rail with reinforced strap should be used. (GCC Door Rail catalogue refers.) or use centre fitting (see page 6)

**Why these fittings look so terrible?
Because inappropriate materials
and finishes will cause rust and
oxidize.**

* With Brass cover



All covers for **GCC** fittings are manufactured by using high grade SUS 304 stainless steel sheet, precision stamping process and polished meticulously and body using High Density Aluminium Alloy to meet industry standards.

GT Series



GP Series

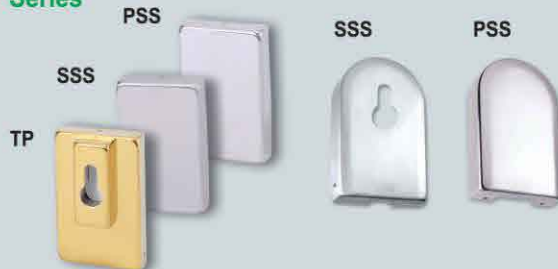

- All fittings are suitable for 10mm or 12mm(3/8" or 1/2") Thick Tempered Safety Glass.
- Special for 15mm(19/32") or 19mm(3/4") glass use available by order.
- Separate glass notching details are available upon request.

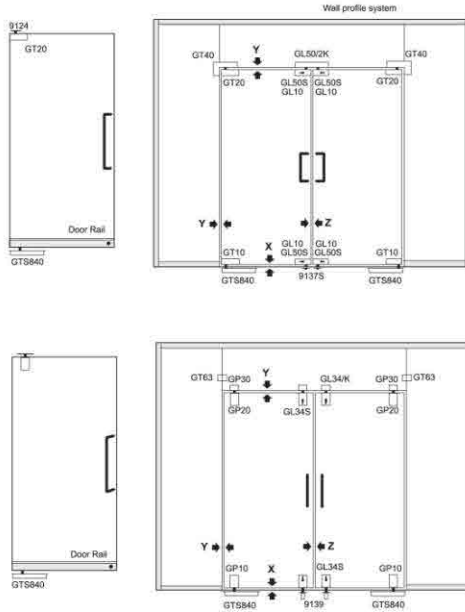

Available finishes for covers:
PSS: Polished Stainless Steel.
SSS: Satin Stainless Steel.
TP: Titanium plated. (PVD coated as Gold color.)

Solid Brass Cylinders



Accessories

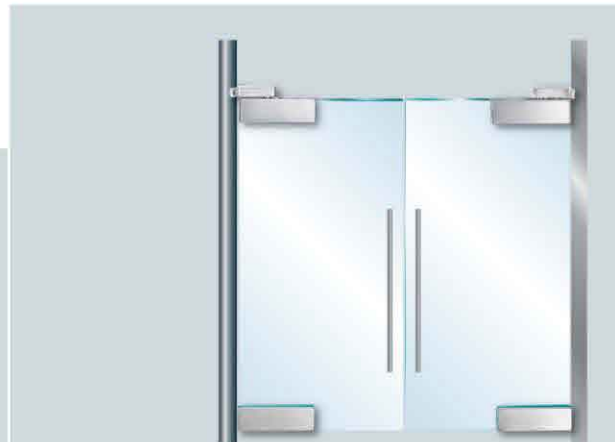

9146C Top Pivot

* For Fix Ø2" Tube to Holding GT 20.



9146F Top Pivot

* For Fix Flat Tube or wall to Holding GT 20.



* Every 300mm one clamp.



Wall profile system

WP 10 • For 10mm(3/8")Glass Thickness.
WP 12 • For 12mm(1/2")Glass Thickness.

- * No messy sealant.
- * No holes required.
- * Easy and quick installation.
- * 3000mm stock length.

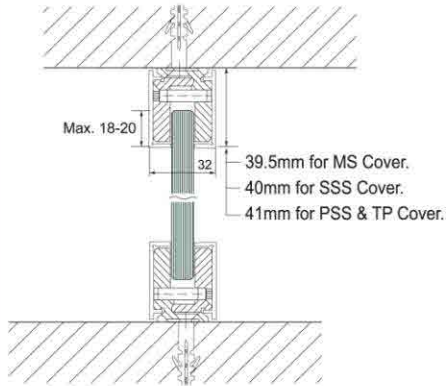

End Cap

Available finishes for cover:

- MS** : Aluminium anodized-mat silver
- PSS**: Polished Stainless Steel.
- SSS**: Satin Stainless Steel.
- TP** : Titanium plated.(PVD coated as Gold color.)

Stainless steel in PSS, SSS & TP finish.

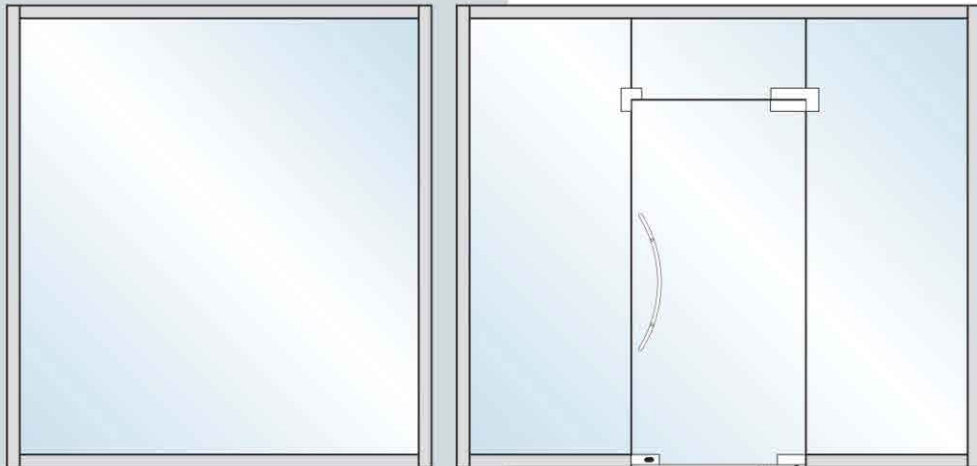

GTS840

9118
Adjustable top centre

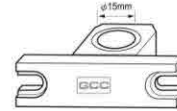
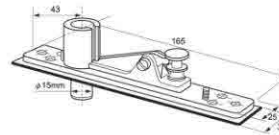

Top insert to fit GP 20 for 9124, 9129 pivot or 9118 Adjustable top centre.

GP 20
GP 20R

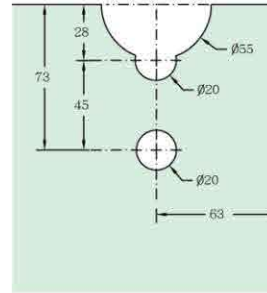

GP 10
GP 10R

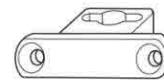
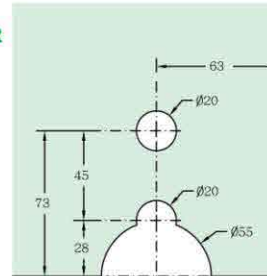

Stainless steel pivot insert to fit GP10, GP10R For **GCC** GTS-650,GTS-840 Floor spring and Germany floor spring or 9115 SUS 304 Floor pivot bearing.



9124 SUS 304 Top Pivot

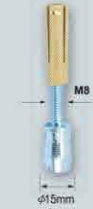

9129 Floor spring Pivot with threaded rod & solid brass wall plug.

GP 20 Top fitting

* With top insert



GP 20R Top fitting

* With top insert



GP 10 Bottom fitting

* With stainless steel pivot insert



GP 10R Bottom fitting

* With stainless steel pivot insert



9115 SUS 304 Floor pivot bearing
*Load capacity: 200Kgs.



GTS-840 Floor spring
(See **GCC** GTS-840 Floor spring catalogue)



GTS-650 Floor spring
(See **GCC** GTS-650 Floor spring catalogue)

GP 30 Overpanel fitting
GP 30R Overpanel fitting

* With pivot ϕ 15mm to fit GP 20, GP 20R



GP 30

GP 30R

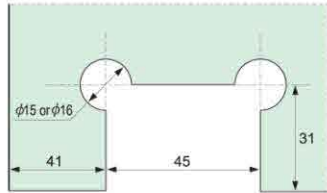
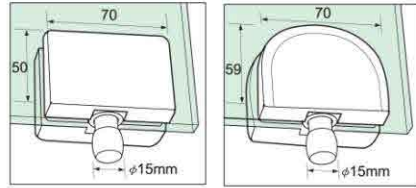

GP 30 GP 30R

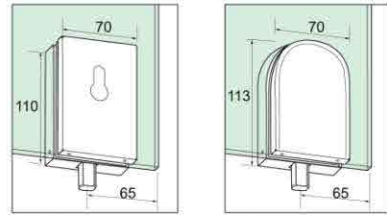

GL 34S

GL 34R

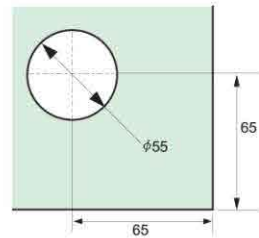
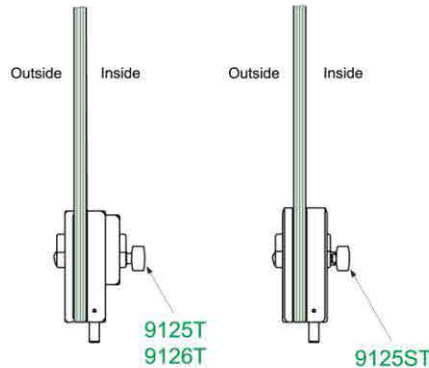

GL 34S GL 34R

9125ST
 Europrofile Solid Brass Cylinder



Clear PVC Seals

W/ Weather Strip

The advantage of the weatherstripping in its ability to limit the circulation of air between indoors and outdoors. As such, the temperature to the air-conditioned room or building is maintained. Dirt and Dust is also prevented from entering the room or building.

"U" Jame

• Supplied in 2500mm(99") stock length.

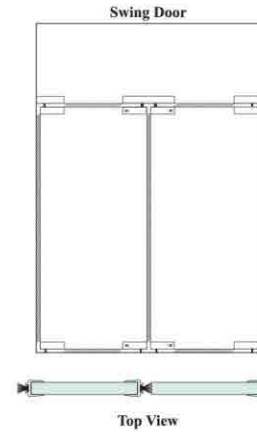
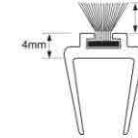

"F" Jame

• Supplied in 2500mm(99") stock lengths.

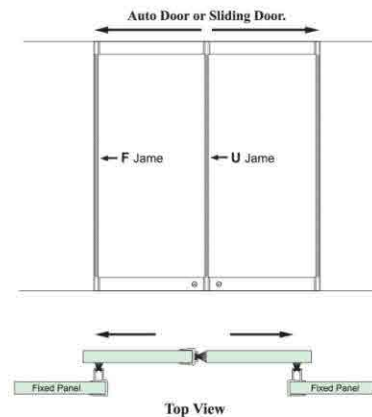
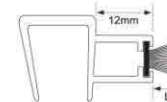

Code No.	Glass Thick	Weather Strip High(L)
PU1006	10mm(3/8")	6mm(1/4")
PU1008	10mm(3/8")	8mm(5/16")
PU1010	10mm(3/8")	10mm(3/8")
PU1206	12mm(1/2")	6mm(1/4")
PU1208	12mm(1/2")	8mm(5/16")
PU1210	12mm(1/2")	10mm(3/8")



Code No.	Glass Thick	Weather Strip High(L)
PF1010	10mm(3/8")	10mm(3/8")
PF1013	10mm(3/8")	13mm(17/32")
PF1020	10mm(3/8")	20mm(13/16")
PF1210	12mm(1/2")	10mm(3/8")
PF1213	12mm(1/2")	13mm(17/32")
PF1220	12mm(1/2")	20mm(13/16")



GT 80 Connector fitting

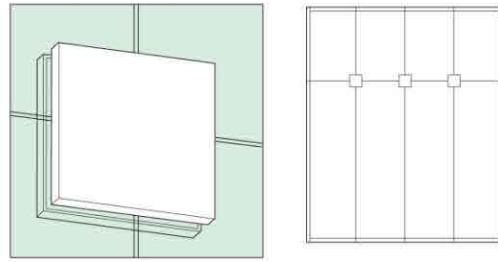
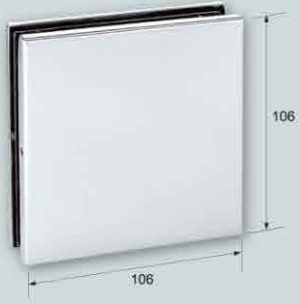

GT80, GT81

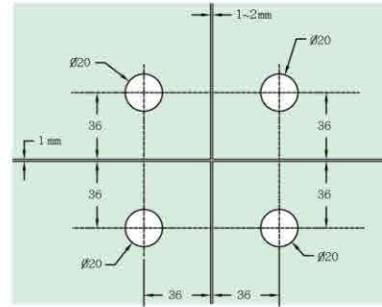

GT 81 Connector with fin fitting

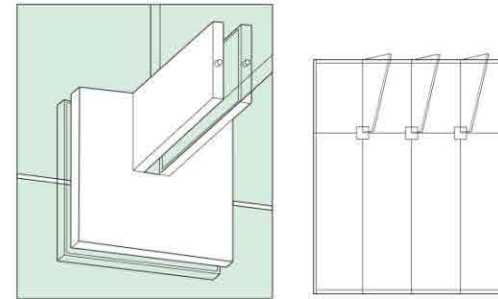

GT81 Fin Notching detail

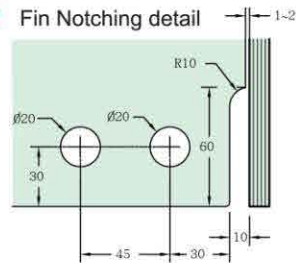

Photoed in Singapore
 * Differential design/size fittings for glass curtain wall is acceptable by order.

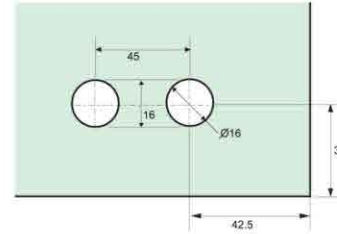
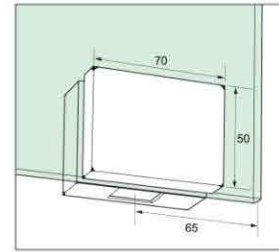

GL 34/K GL 34/RK

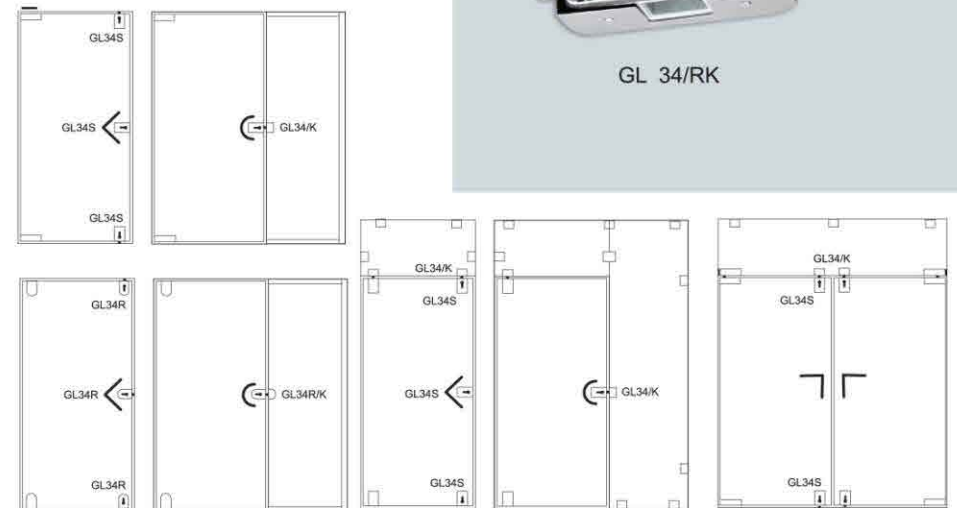
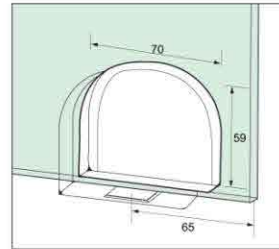

GL 34/K Strike box
GL 34/RK Strike box

* For GL 34S, GL 34R Patch lock in overpanel or centre.



GL 34/K



GL 34/RK

GT 20 Top fitting

* With top insert

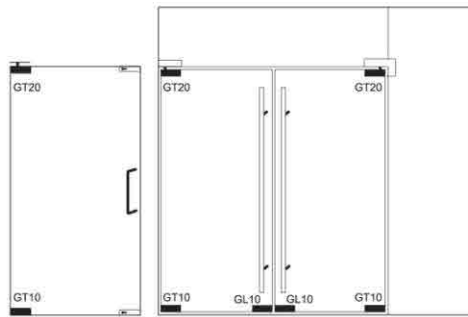

GT 10 Bottom fitting

* With stainless steel insert
DT, MT, NT, AT, KT optional.

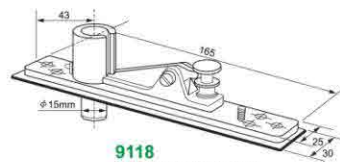

9118
Adjustable top centre

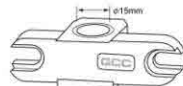

Top insert for fit GT20 for 9124, 9129 Pivot or 9118 Adjustable top centre.

GL 10 Corner lock

* prepared for Europrofile cylinder.
* GCC Europrofile cylinder No.9125ST.
* Glass Notching same as GT 10, GT 20



Stainless Steel Insert(Optional):

DT: Fits GTS-650 GTS-840 Floor spring, 9115 SUS 304 Floor Pivot Bearing or Germany Floor Spring.(Standard in stock)

MT: Fits Italy Floor Spring.

NT: Fits Japan Floor Spring.

AT: Fits Japan Floor Spring.

KT: Fits Korea Floor Spring.



9125ST

Europrofile Solid Brass Cylinder



GTS-650 GTS-840 Floor spring
(See GCC GTS-840 Floor spring catalogue)
(See GCC GTS-650 Floor spring catalogue)



9115
SUS 304 Floor pivot bearing

CL 42 Glass clamp

* Made by heavy duty SUS 304 stainless steel.
* For join overpanel and sidepanel to reduce flexing when pressure is applied.

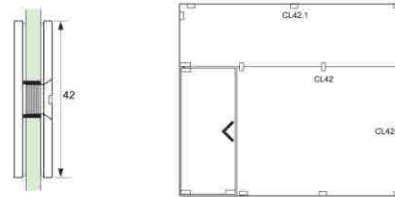

CL 42.1 Side connector

* Made by heavy duty SUS 304 stainless steel.
* For hold fixing panel.

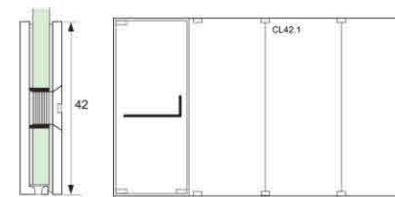

GL 42

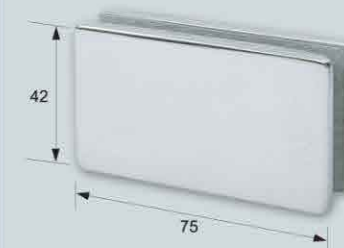

GL 42.1

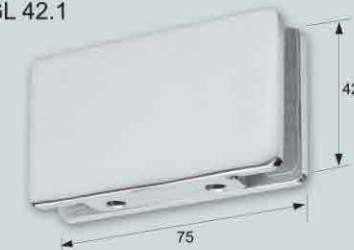

GL 52 Turn knob lock

* No need key, simply lock with thumb from inside.

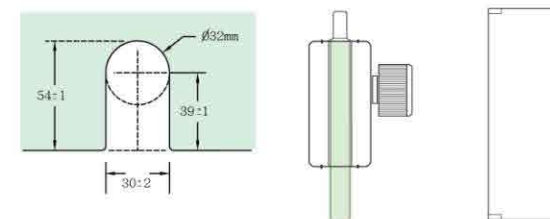

9145

Keeper plate
• For GL 52 Fix to wall



GL 52



GL 52/K Strike box

* For fix GL 52 Turn knob lock

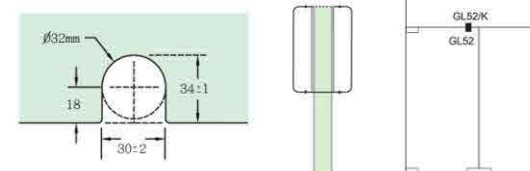

GL 52/K



GT 60
Corner transom connector



GT 60

- * For overpanel and sidepanel.
- * With reversible door stop insert for single action to make the door swing out or in.
- * Removing the reversible door stop insert you will have a double action door.

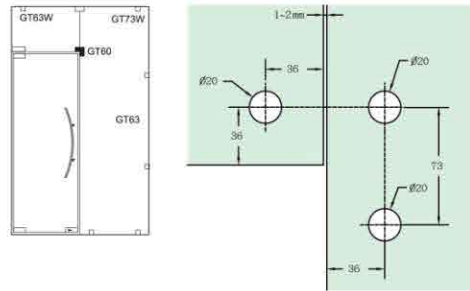

9129 Top Pivot

- *Pivot with threaded rod & solid brass wall plug.



9124

SUS 304 Top Pivot

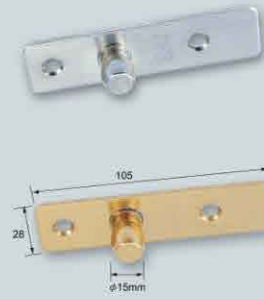

GT 20C Top Centre Fitting

- * For door panel width up to or over 1200mm.



GT 70 Overpanel connector
(Door stopper)



GT 70

- * With two reversible stop inserts for single action to make the door swing out or in.

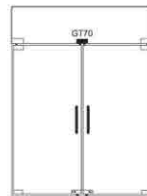

GT 70 Notching detail

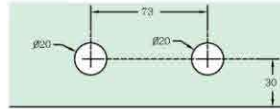

GT 70 Notching detail-double panels

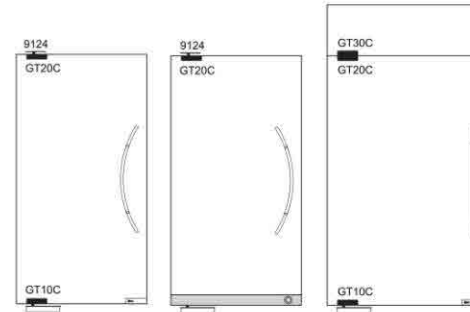
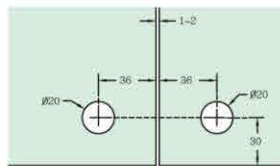

GT 10C Bottom Centre Fitting

- * For door panel width up to or over 1200mm.



GT 71 Overpanel connector
with fin fitting



GT 71

- * Special designed adjustable fin suitable for glass thickness 10mm, 12mm & 15mm.
- * Fix overpanel with support fin to achieve the desired structural strength.
- * For support glass partition or glass curtain wall with fin.

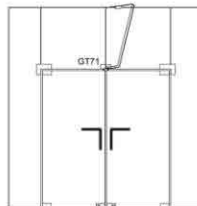

GT 71 Notching detail

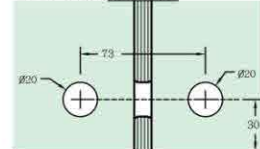

GT 71 FIN Notching detail

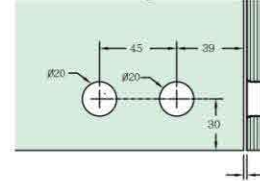

GT 20C Top Centre Fitting

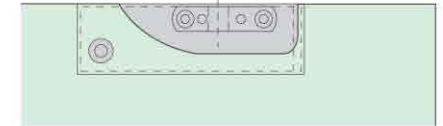
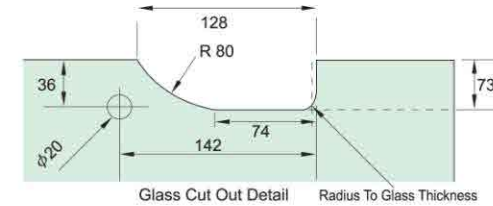

GT 10C Bottom Centre Fitting

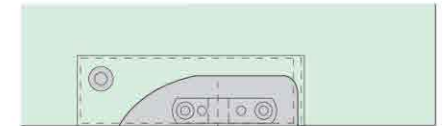
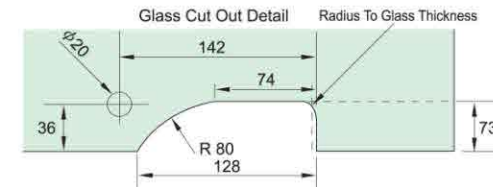



GTS-850 Concealed overhead closer
(See **GCC** GTS-850 Concealed overhead closer catalogue)

GT 22 Top fitting

* With square insert for **GCC** GTS-850 Concealed overhead closer

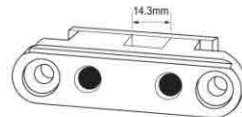
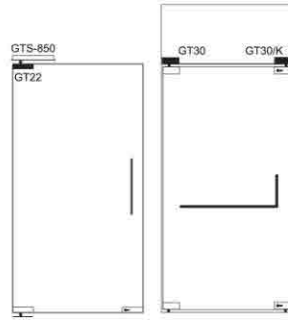

Square top insert for fit GT22 for GTS-850 Concealed overhead closer.

GT 30 Overpanel fitting

* Prepared M8 Tapped hole at side for 9130 threaded rod or 9140 Alum. fixing plate.
* With pivot ϕ 15mm.

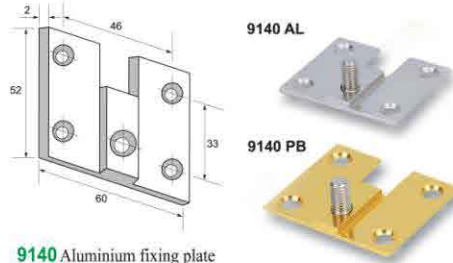

9140 Aluminium fixing plate
(Optional for GT30, GT30/K)

GT 30/K Overpanel strike box

* Prepared M8 Tapped hole at side for 9130 threaded rod or 9140 Alum. fixing plate.
* For GL 50S, GL 50N Corner Lock.



9130 Fixing Screw
Threaded rod M8 with brass wall plug.
(Optional for GT30, GT30/K, GT63W, GT63C, GT73W)

example



GT 63 Glass clamp

* For join overpanels and sidepanels to reduce flexing when pressure is applied.

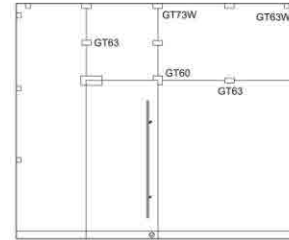

GT 63W Side connector

* For hold fixed panel or support fin bracket.
* Can be used with fixing plate or fixing screw, please specify when ordering.



GT 63C Corner fitting

* For joint overpanel at corner to wall.



9141
For GT Fixing plate 63W
GT 63C

9142
For GT Fixing plate 73W



GT 73W Side connector

* For hold fixed panel or support fin bracket,
* Can be used with fixing plate or fixing screw, please specify when ordering.

9130 fixing screw



GT 63W
GT 63C

GT 73W



for GT63C
GT63W
GT73W



GL 35 Patch lock

- * For vertical fixing at centre or horizontal fixing at corner.
- * Lock mechanism part & Solid brass cylinder No.9127 included.
- * For security, inside hardened roller pin included.

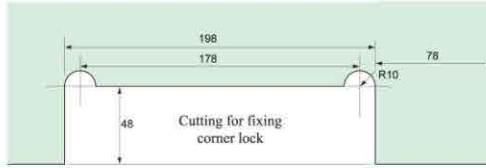

9138 Keeper cup



GL 35/K Strike box

- * For GL 35 Patch lock fixing at centre

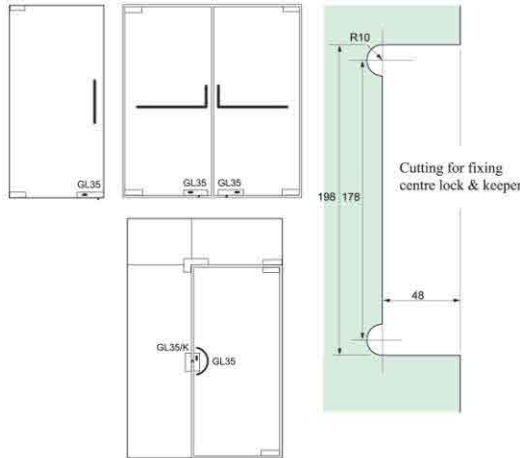

- * For right or left side door, GCC special design L brackets can be reversed & installed in lock mechanism part & strike plate easily by using screw driver only.
- * Patented.



GL 35

GL 35/K

- * For security and easy installation, all screw heads are in one side fixing and keep in inside door.

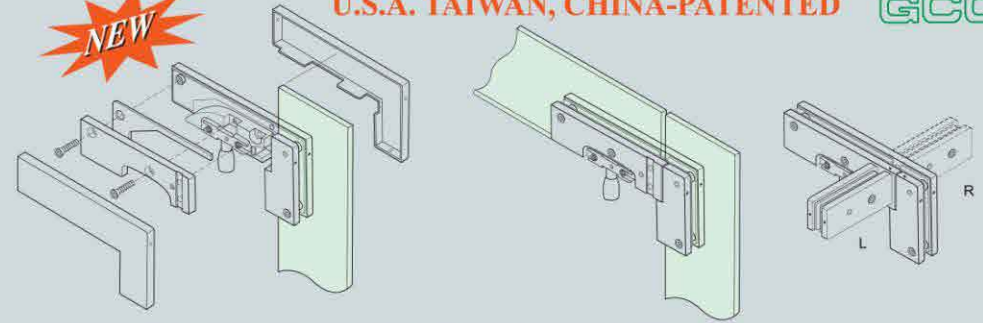

- Its installation is easy-unique designed body in three pieces, a great deal of time and effort can be saved by separate installation in sidepanel and overpanel.
- Same body construction for GT 40, GT40/S, GT 40/K, GT40/KS, GT 41 and GT 41/K and GT 41/KS.

GT 40 Corner transom fitting

- * Two options in the pivot point, distance from the sidepanel for frame can be either 55mm or 65mm.

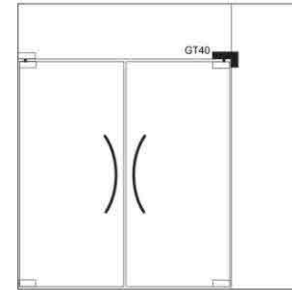

GT 40 Corner transom fitting

- * For overpanel and sidepanel.
- * With pivot ϕ 15mm.



GT 40/K Corner transom strike box

- * For overpanel and sidepanel.
- * For GL 50S, GL 50N Corner lock on top.

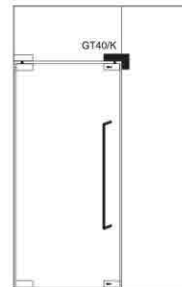

GT 40/K Corner transom strike box

- * For GL 50S, GL 50N Corner lock on top.



GT 41 Corner transom fitting with Fin

- * For overpanel and sidepanel with fin fitting inside.
- * With pivot ϕ 15mm for fit GT 20 same as GT 40.
- * Right fin (GT 41R) or Left fin (GT 41L).

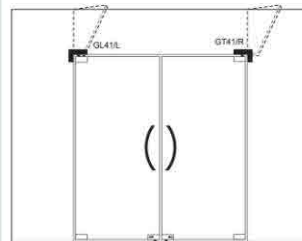
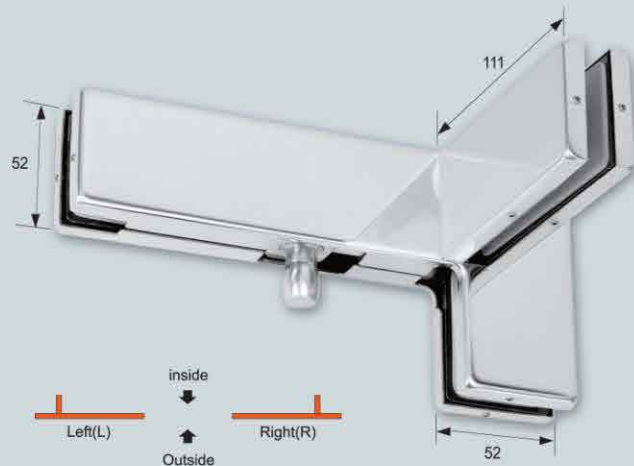

Fin Notching detail
GT41, GT41/K, GT41/KS

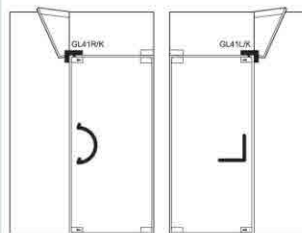
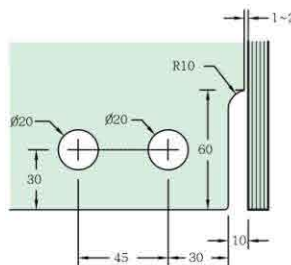

GT 41/K Corner transom strike box with fin

- * For overpanel and sidepanel with fin fitting inside.
- * For GL 50S, GL 50N Corner lock on top.
- * Right fin (GT 41R/K) or Left fin (GT 41L/K).

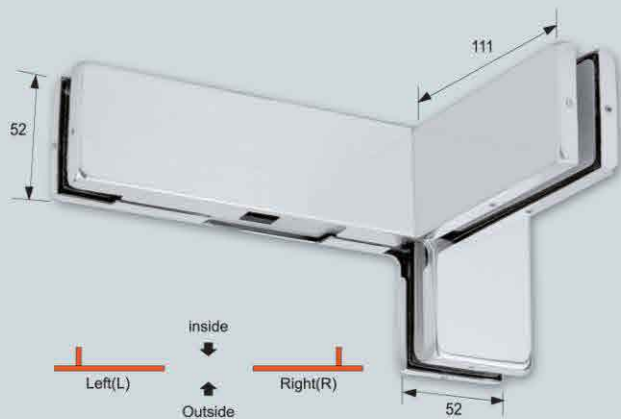

NEW Patented

GL 24, GL24K GL24/2, GL24/2K

- * No need to cut glass.
- * Can be fixed in any place of the glass door & fixed panel.
- * Prepared for Europrofile cylinder.
- * GCC European cylinder No. 9125H, 9126H, 9125HT.

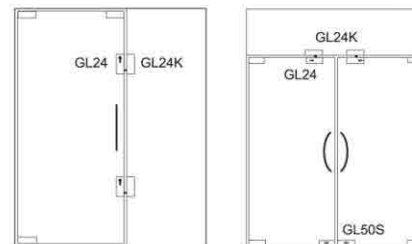

GL 24/2 Patch lock

- * Lockable at both sides by using key or thumbturn cylinder is optional.

GL 24/2K Strike box

- * For GL24/2 Patch lock.



GL 24/2K GL 24/2



GL 24 Patch lock

- * Lock from one side only.
- * Can be re-move to any place easily by loosung screws.
- * For right or left side door(right hand or left hand).
- * GCC Lock mechanism part & strike box also can be reversed easily by loosung screws.

GL 24K Strike box

- * For GL24/2 Patch lock.



GL 24K GL 24



GL 24 GL 24K

GL 50/2K Double overpanel strike box

* To suit GL 50S, GL 50N Corner locks double on top.

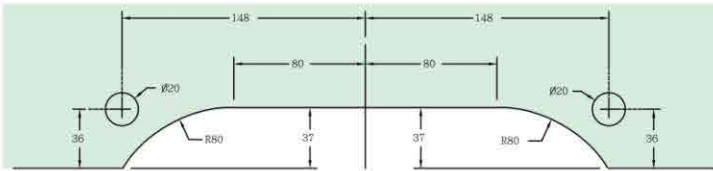
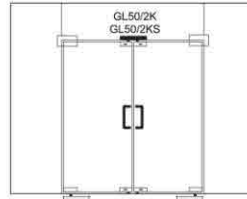

Notching detail
GL 50/2K
GL 50/2KS
GT 51

GL 50/2KS

Double overpanel strike box W/Stopper

* To suit GL 50S, GL 50N Corner locks double on top & with stopper.
* Stopper reversible for single action to make the door swing in or out.



GT 51 Overpanel fitting

* With fin fitting inside for back to back doors.
* With two pivots ϕ 15mm for fit GT 20.
* Fin notching same as GT 41.



Fin Notching detail
GT 51

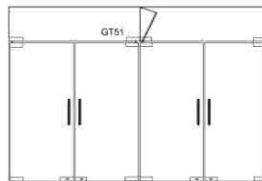
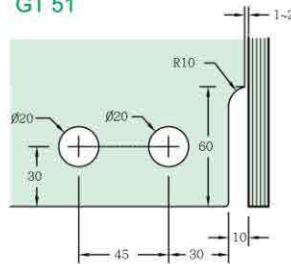

GT 40/S

Corner transom stopper

* For overpanel and sidepanel.
* Stopper reversible for single action to make the door swing in or out.

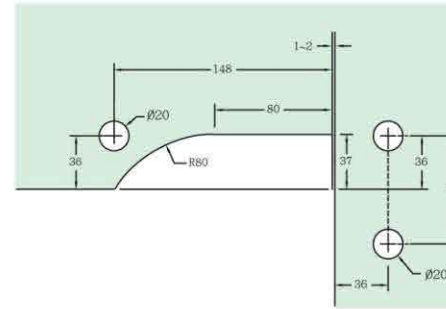

Notching detail
GT 40, GT 40/K, GT 40/S, GT 40/KS
GT 41, GT 41/K, GT 41/KS

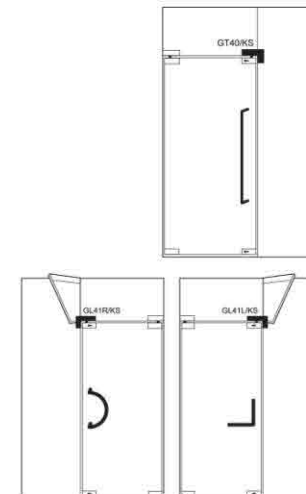

GT 40/KS

Corner transom strike box with stopper

* For overpanel and sidepanel.
* For GL 50S, GL 50N Corner lock on top.
* Stopper reversible for single action to make the door swing in or out.



GT 41/KS

Corner transom strike box with fin & stopper

* For overpanel and sidepanel.
* For GL 50S, GL 50N Corner lock on top.
* Stopper reversible for single action to make the door swing in or out.



GL 50N Corner lock

- * Prepared for Europrofile cylinder
- * **GCC** Europrofile cylinder No.9125, 9125T, 9126, 9126T



GL 50S Corner lock

- * Prepared for Europrofile cylinder
- * **GCC** Europrofile cylinder No.9125, 9125T, 9126, 9126T



GL 50S
GL 50N



* Both notches are suitable for GL 50S, GL 50N Corner lock *

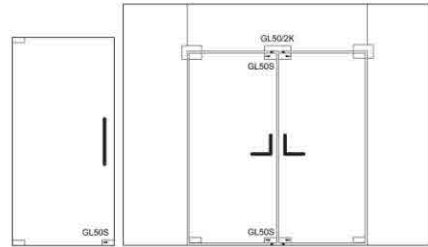
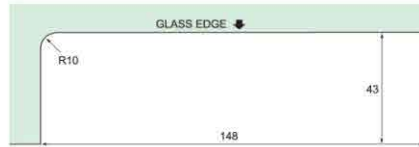

- * For security and easy installation, all screw heads are in one side fixing and keep in inside door.
- * No need to take down the door when changing Europrofile cylinders, simply use one screw driver.
- * For right or left side door, **GCC** lock mechanism part can be reversed easily by loosening two screws only.
- * For security, inside hardened roller pin included.

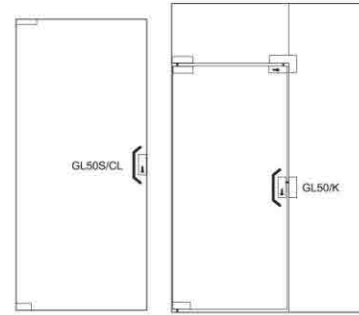

- * For security and easy installation, all screw heads are in one side fixing and keep in inside door as GL 50S.
- * For right or left side door, **GCC** lock mechanism part & strike plate can be reversed easily by loosening two screws only.
- * For security, inside hardened roller pin included.

9137S keeper cup



9135 SUS 304 keeper plate



9135B Brass keeper plate



GL 50S/CL Centre lock

- * Prepared for Europrofile cylinder
- * **GCC** Europrofile cylinder No.9125, 9125T, 9126, 9126T

GL 50/K Strike box

- * For GL 50S/CL Centre lock



GL 53 Centre lock

- * Hock type for sliding door.
- * Prepared for Europrofile cylinder
- * **GCC** Europrofile cylinder No.9125, 9125T, 9126, 9126T

GL 53/K Strike box

- * For GL 53 Centre lock.

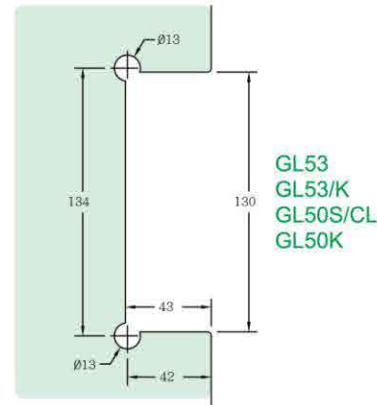

GL 53
GL 53/K
GL 50S/CL
GL 50K



GL 53/K

GL 53

9148 SUS 304 keeper plate



9135 SUS 304 keeper plate



9137S Keeper cup



9139

Floor socket
* with spring & dust cover



9139P

Floor socket with plate
* with spring & dust cover

