



In the field of architectural fittings for aluminum & tempered glass doors, both high quality and total design flexibility are essential criteria together with ease of installation, safety and function.

GCC full range of fittings are aesthetically designed and manufactured to provide practicality and security to tempered glass assemblies, such as Tempered Glass Door Fittings, PVC Seals W/Weather Strips, Glass Clamps, Shower Door Hinges, Handles & Knobs, PVC Seals & Wipes and Reinforcement Bars for Shower Screen. Door Rails, Pivoting Door systems, office partition systems, Lever Hinges & Locks, Heavy-Duty Sliding Wall systems, Heavy Duty Sliding & Folding Door System, Floor Spring, Concealed Overhead Door Closer, Glass Connectors....etc. For details welcome to visit our website at www.gccintw.com.tw

GCC will be happy to help your special requirements, for any doubts, please contact your nearest **GCC** distributors for any technical assistance on parts and services, or contact us directly.

If you are looking for high quality products, **GCC** is your best choice.



FRAMELESS

Shower Screen Systems



Agent/ Distributor



GOOD CREDIT CORPORATION

No.13, Longmen Rd., Situn Dist., Taichung 40757, Taiwan

E-mail: gccintw@ms7.hinet.net

TEL: 886-4-22583755(Hunting Line)

FAX: 886-4-22583753

<http://www.gccintw.com.tw>



© Copyright 2011.05 Good Credit Corporation

GCC Shower Door Hinges are made from the meticulous process of selecting the finest brass alloys suitable for drop forging, polishing and plating using the most advanced technical know-how, and stainless steel pin to prevent rust.

- Glass Thickness: 8mm(5/16") or 10mm(3/8") tempered safety glass.
- Max. Door Weight: 40Kgs(90Lbs)
- Max. Door Width: 1000mm(39")
- Complete with gaskets, stainless steel screws & wall plugs.
- Standard package: **pair in one box.**

GX 989 Series



Front

GX 990.1B
Wall Mount - One side fixing



Front

GX 992.1B
Wall Mount - One side fixing



Front

GX 680.1B
Wall Mount - One side fixing

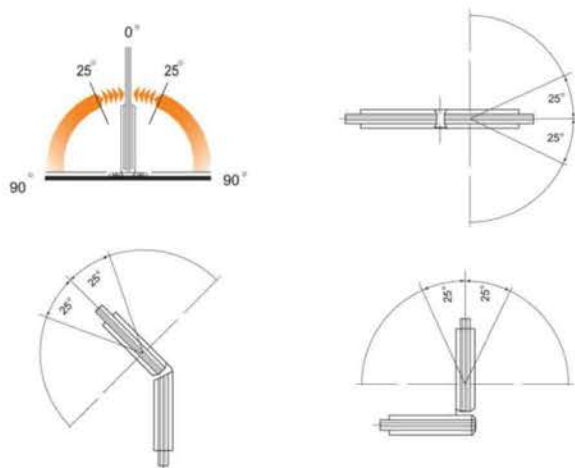

* All hinges are **double action spring** from 0° to 180° with automatic return to centre (self-centering) from approx 25° each side (GX 989, GX 990, GX991, GX992, GX993, GX680 series)

Available Finishes:

- PC: Polished Chrome Plate.
- SC: Satin Chrome Plate.
- PB: Polished Brass with clear varnish coating.
- TP: Titanium Plated (PVD coated as gold color).



* For hold the glass panel tight without loosening after long use, **GCC** use impregnable gaskets and allen-key stainless steel screws to provide a sure grip on glass surfaces.

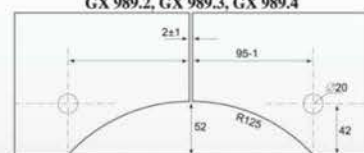
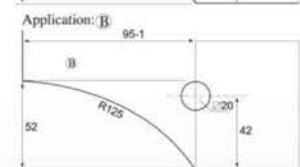
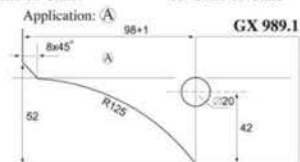
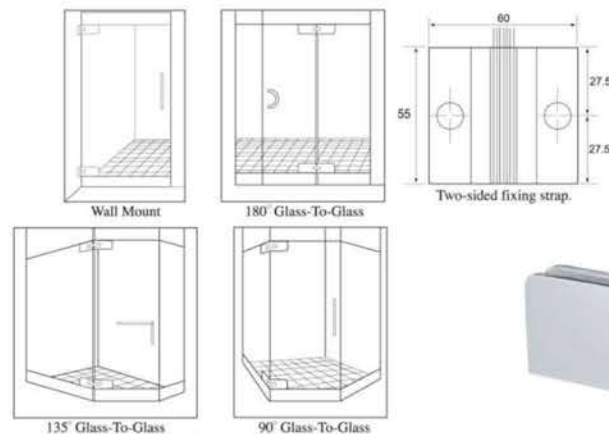

Glass cut-out on both top & bottom corner.

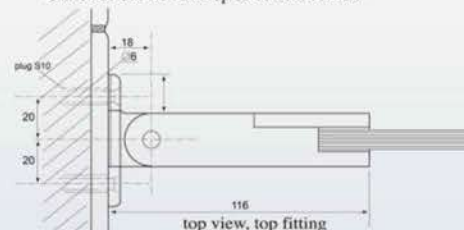

GX 989.1 Wall Mount



GX 989.2 180° Glass-To-Glass



GX 989.3 135° Glass-To-Glass



GX 989.4 90° Glass-To-Glass

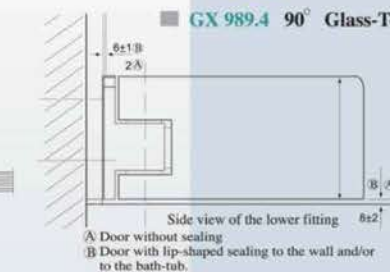

Side view of the lower fitting
A Door without sealing
B Door with lip-shaped sealing to the wall and/or to the bath-tub.

GCC®
GX 990
Series

- Glass Thickness: 10mm(3/8") or 12mm(1/2") tempered safety glass.
- Max. Door Weight: Using 2 hinges for 37Kgs. (80Lbs)
3 hinges for 55Kgs. (121Lbs)
- Max. Door Width: 2 hinges for 800mm (31")
3 hinges for 900mm (35")
- Complete with gaskets, stainless steel screws & wall plugs.
- Standard package: **pair in one box.**



GX 990.1

- GX 990.1 Wall Mount
- GX 990.1B Wall Mount - One side fixing (see page 6)



■ GX 990.2 180° Glass-To-Glass



■ GX 990.3 135° Glass-To-Glass



■ GX 990.4 90° Glass-To-Glass

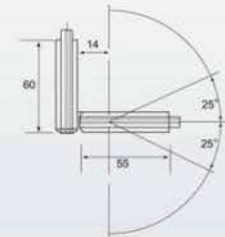
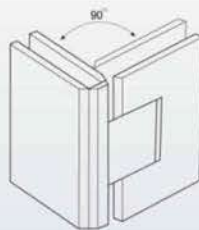
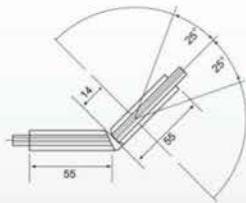
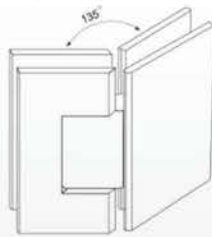
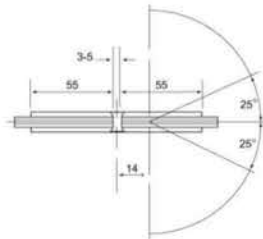
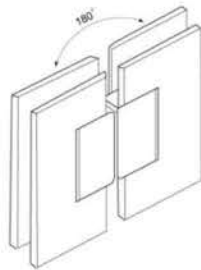
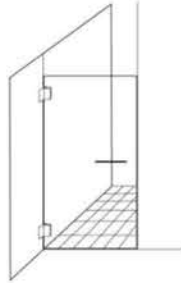
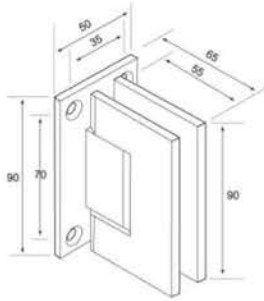

- Glass Thickness: 10mm(3/8") or 12mm(1/2") tempered safety glass.
- Max. Door Weight: Using 2 hinges for 37Kgs. (80Lbs)
3 hinges for 55Kgs. (121Lbs)
- Max. Door Width: 2 hinges for 800mm (31")
3 hinges for 900mm (35")
- Complete with gaskets, stainless steel screws & wall plugs.
- Standard package: **pair in one box.**

GCC®
GX 992
Series

GX 990.1 GX 992.1 GX 993.1
GX 990.1B GX 992.1B GX 993.1B

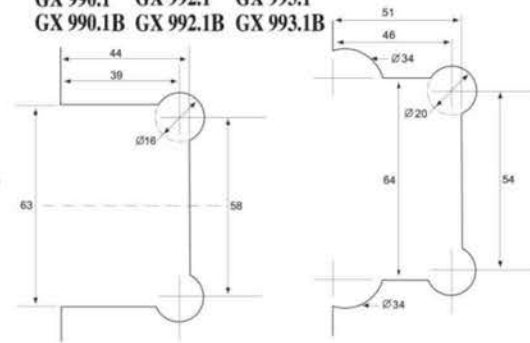

- GX 992.1 Wall Mount
- GX 992.1B Wall Mount - One side fixing (see page 6)

GX 990.2
GX 990.3
GX 990.4
GX 992.2
GX 992.3
GX 992.4
GX 993.2
GX 993.3
GX 993.4

THIS NOTCH WILL MAKE GLASS CLOSE TO WALL

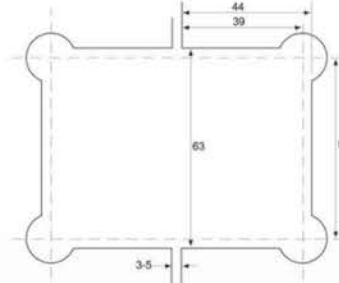

■ GX 992.2 180° Glass-To-Glass



■ GX 992.3 135° Glass-To-Glass



■ GX 992.4 90° Glass-To-Glass

NOTE:
Bevel edge on fixed panel is needed.

GX 990.3
GX 992.3

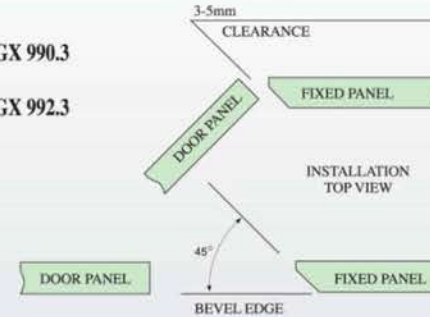

GCC®
GX 993
Series

- Glass Thickness: 10mm(3/8") or 12mm(1/2") tempered safety glass.
- Max. Door Weight: Using 2 hinges for 37Kgs. (80Lbs)
3 hinges for 55Kgs. (121Lbs)
- Max. Door Width: 2 hinges for 800mm (31")
3 hinges for 900mm (35")
- Complete with gaskets, stainless steel screws & wall plugs.
- Standard package: **pair in one box.**

Wall Mount-Offset Back Plate

- One Side Fixing.
- Allows Clean Sight Line From Shower exterior.
- Refer GX990.1,GX992.1,GX680.1 For Notch & Technical Details.



■ GX 993.1 Wall Mount
■ GX 993.1B Wall Mount - one side fixing (see page 6)

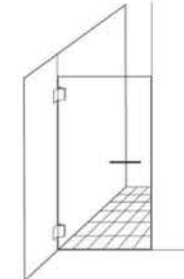
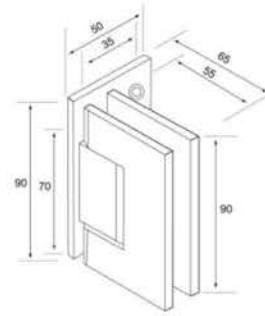
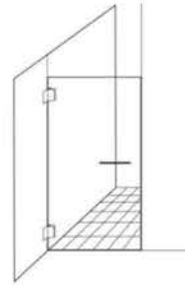
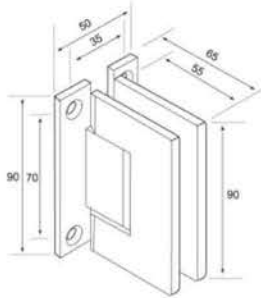

Front



Rear

■ GX 990.1B Wall Mount - One side fixing



■ GX 993.2 180 Glass-To-Glass

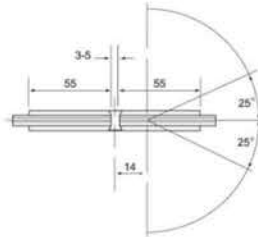
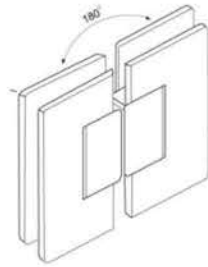

GX 990.1B GX 992.1B

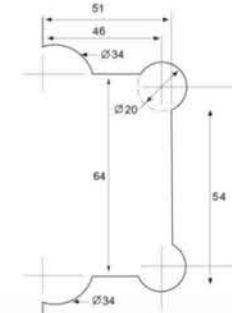
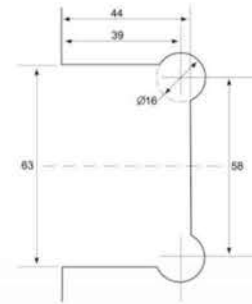

THIS NOTCH WILL MAKE GLASS CLOSE TO WALL



Front



Rear

■ GX 992.1B Wall Mount - one side fixing



■ GX 993.3 135 Glass-To-Glass

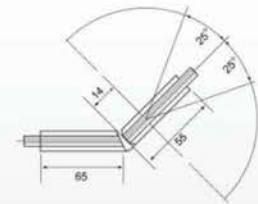
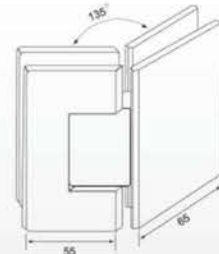

GX 680.1B

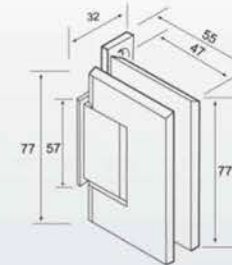

Front



Rear

■ GX 680.1B Wall Mount - One side fixing



■ GX 993.4 90 Glass-To-Glass

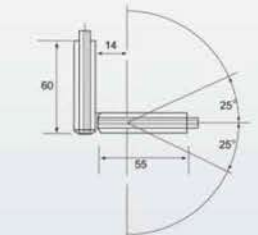
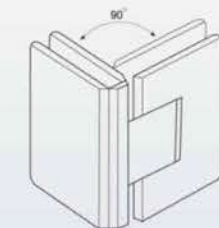

GCC®
GX 991
Series

- Glass Thickness: 8mm(5/16") or 10mm(3/8") tempered safety glass.
- Max. Door Weight: Using 2 hinges for 40Kgs. (90Lbs)
 3 hinges for 50Kgs. (110Lbs)
- Max. Door Width: 2 hinges for 800mm (31")
 3 hinges for 900mm (35")
- Complete with gaskets, stainless steel screws & wall plugs.
- Standard package: **pair in one box.**

※ The series can be mounted on glass within the door or at corner



GX 991.1, GX 991.1B, GX 991.2,
GX 991.3, GX 991.4, GX991.5



■ GX 991.1 Wall Mount

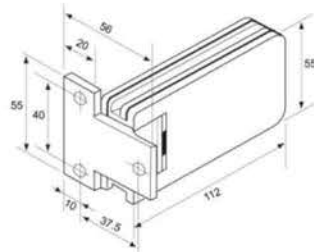

Mounted within door

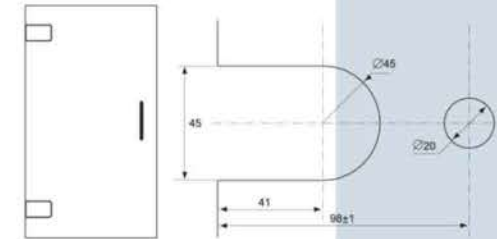

■ GX 991.1B Wall Mount - One side fixing

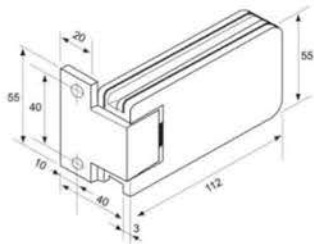

Mounted at the corner

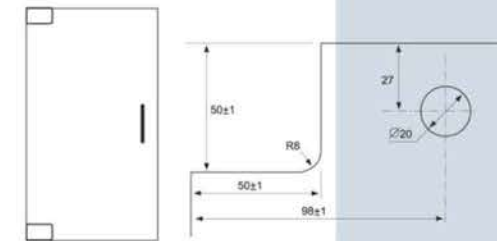

■ GX 991.2 180° Glass-To-Glass

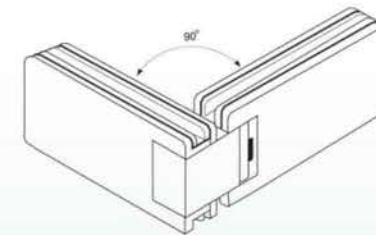
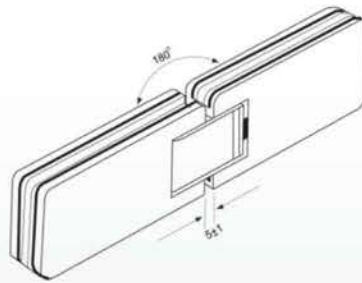

■ GX 991.4 90° Glass-To-Glass



■ GX 991.3 135° Glass-To-Glass

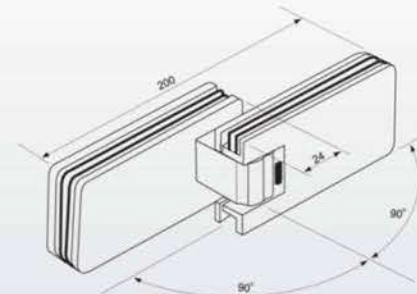
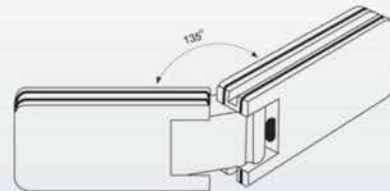

■ GX 991.5 180° Folding Glass-To-Glass



GCC® GX 680 Series

Glass Thickness: 6mm(1/4") or 8mm(5/16") tempered safety glass.
 Max. Door Weight: Using 2 hinges for 27Kgs. (60Lbs)
 3 hinges for 40Kgs. (90Lbs)
 Max. Door Width: 2 hinges for 700mm (28")
 3 hinges for 800mm (32")
 Complete with gaskets, stainless steel screws & wall plugs.
 Standard package: **pair in one box.**

※Self-centering at around 20° of closed position each side.



GX 680.1

- GX 680.1 Wall Mount
- GX 680.1B Wall Mount - One side fixing (see page 6)



■ GX 680.2 180° Glass-To-Glass



■ GX 680.3 135° Glass-To-Glass



■ GX 680.4 90° Glass-To-Glass

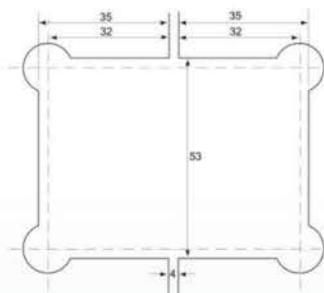
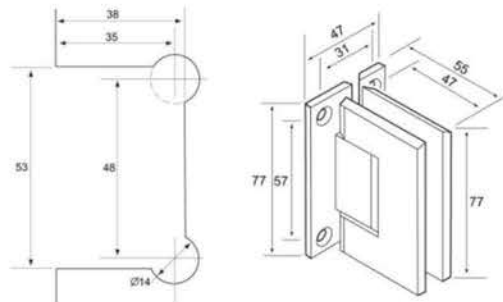

GX 680.2
GX 680.3
GX 680.4

NOTE:
Bevel edge on fixed panel is needed for GX 680.3

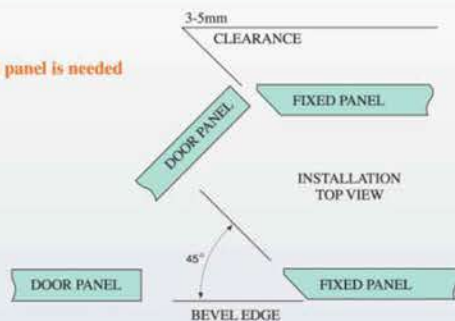

Glass Clamps-For fixed panel



- Complete made of the SUS 304 Stainless Steel. (SUS 316 Stainless Steel available by order)
- Size: 45x48mm(1-3/4"x1-7/8")each plate.
- Glass Thickness Range: 6mm(1/4"), 8mm(5/16"), 10mm(3/8") or 12mm(1/2") tempered safety glass.
- Hole Size Required: ϕ 16mm(5/8").
- Complete with gaskets, stainless steel screws & wall plugs.

Available Finishes:

PSS:Polished Stainless Steel.

SSS:Satin Stainless Steel.

TP:Titanium plated.(PVD coated as

Gold color but never change).

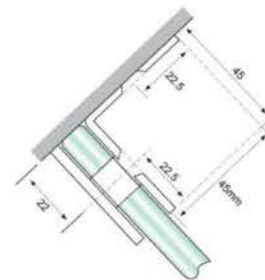

■ GX 45.1L Wall Mount-L Type

■ GX 45.1 Wall Mount

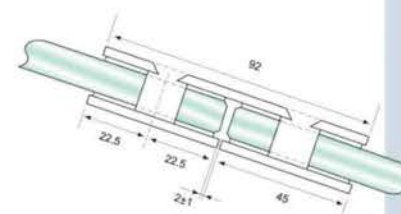

■ GX 45.2 180° Glass to Glass

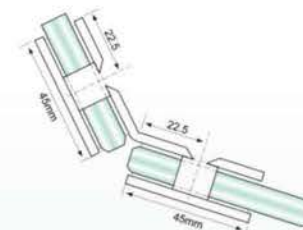

■ GX 45.3 135° Glass to Glass

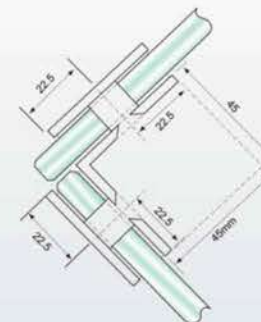
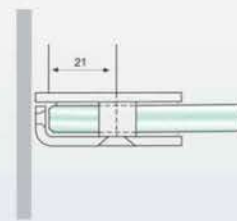
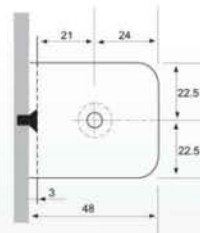

■ GX 45.4 90° Glass to Glass

Glass Clamps-For Fixed Panel

- **Material:** Drop Forged Solid Brass.
- **Glass Thickness Range:** 8mm(5/16"), 10mm(3/8") or 12mm (1/2") tempered Safety glass.
- **Hole Size Required:** Ø16mm(5/8").
- **Complete with Gaskets, Stainless Steel Screws & Wall Plugs.**



GX 50.1 Wall Mount



GX 50.2 180° Glass to Glass



GX 50.3 135° Glass to Glass



GX51.1HL Wall mount

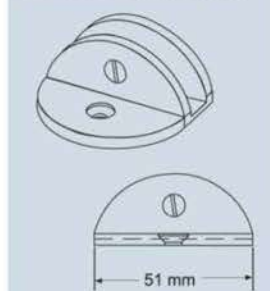

GX51.1VL Wall mount

Available Finishes:

- PC: Polished Chrome Plate.
- SC: Satin Chrome Plate.
- TP: Titanium Plated (PVD coated as gold color)

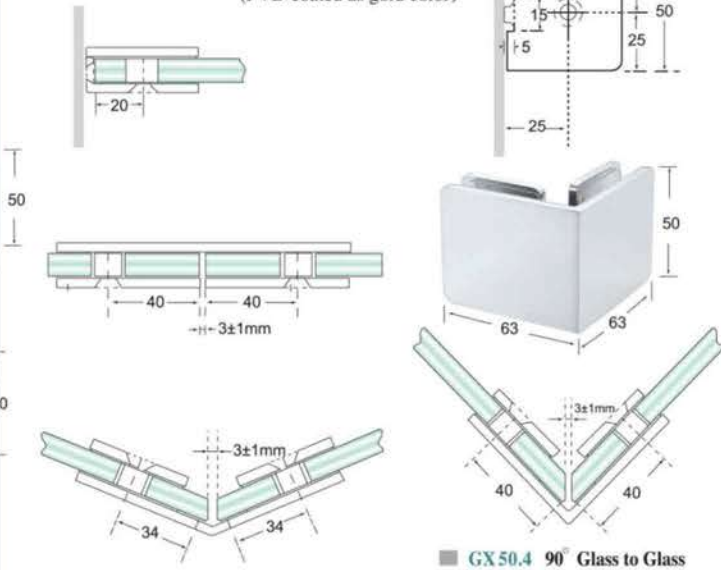

- Suitable for 8, 10mm thick glass.
- For fixing point is away from edge of tile or wall.
- Bracket with horizontal leg.
- **No hole required.**



- Suitable for 8, 10mm thick-glass.
- For fixing point is away from edge of tile or wall.
- Bracket with Vertical leg.
- **No hole required.**

Knobs

All knobs are suitable for 6mm(1/4"), 8mm(5/16"), 10mm(3/8") & 12mm(1/2") thickness glass.
Hole Diameter: 10mm(3/8") or 12mm(1/2").



* Single-sided type is available for all models by order except KB/4035



Model: KB/4025
Material: Solid Brass
Finish:
PC: Polished Chrome Plate.
PB: Polished Brass W/clear lacquer.
SC: Satin Chrome Plate.
TP: Titanium Plated(PVD coated as Gold color).

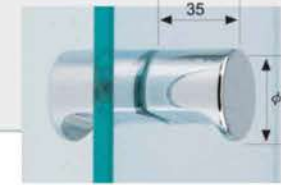

Model: KB/4035
Material: Solid Brass
Finish:
PC: Polished Chrome Plate.
PB: Polished Brass W/clear lacquer.
SC: Satin Chrome Plate.
TP: Titanium Plated(PVD coated as Gold color).

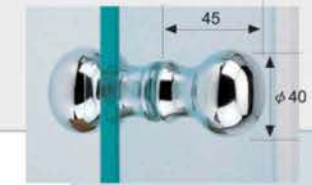

Model: KB/4045
Material: Solid Brass
Finish:
PC: Polished Chrome Plate.
PB: Polished Brass W/clear lacquer.
SC: Satin Chrome Plate.
TP: Titanium Plated(PVD coated as Gold color).

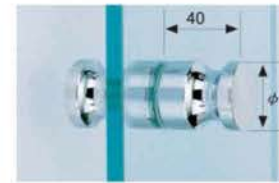

Model: KB/3540
Material: Solid Brass
Finish:
PC: Polished Chrome Plate.
PB: Polished Brass W/clear lacquer.
SC: Satin Chrome Plate.
TP: Titanium Plated(PVD coated as Gold color).

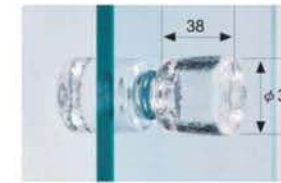

Model: CKB/3838
Material: Pure Glass with Solid Brass base.
Finish:
PC: Polished Chrome Plate.
TP: Titanium Plated(PVD coated as Gold color).



Model: CKB/4050 φ 40mm
Model: CKB/5060 φ 50mm
Material: Crystal with stainless steel base.
Finish:
PSS: Polished Stainless Steel.
TP: Titanium Plated(PVD coated as Gold color).

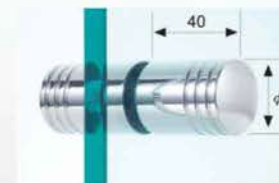

Model: KB/3040
Material: Solid Stainless Steel.
Finish:
PSS: Mirror Polished.
SSS: Satin (Hairline) Polished.
TP: Titanium Plated (PVD coated as Gold color).

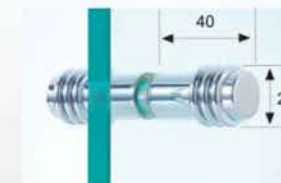

Model: KB/2440
Material: Solid Brass
Finish:
PC: Polished Chrome Plate.
SC: Satin Chrome Plate.
TP: Titanium Plated(PVD coated as Gold color).



GCC® Pull and Towel Bar Sets

- All **GCC** Pull and Towel Bar Sets are constructed of heavy wall SUS 304 stainless steel tubing. Tubing Diameter: 19mm(3/4")
- Fits glass thickness from 6mm(1/4") to 12mm(1/2")
- Available Finishes: **PSS**: Polished Stainless Steel.
SSS: Satin Stainless Steel.
TP: Titanium plated. (PVD coated as Gold color)

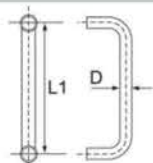

SIZE(mm)

L1(C/C)mm	D m/m
150(6")	19(3/4")
200(8")	19(3/4")
250(10")	19(3/4")
305(12")	19(3/4")
450(18")	19(3/4")

■ H01

■ H01S • Single Side Towel Bar for Glass Doors or Panels.

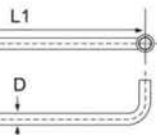
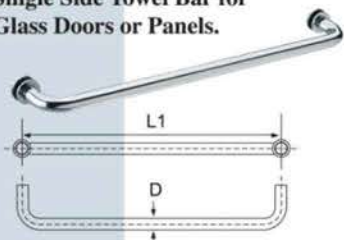

■ H01SK • Single Side Towel Bar w/Knob.



SIZE(mm)

L1(C/C)mm	D m/m
305(12")	19(3/4")
450(18")	19(3/4")
600(24")	19(3/4")

■ H12 • Pull and Towel Bar Sets.

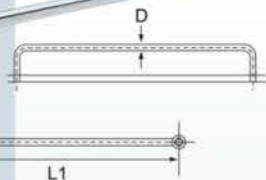
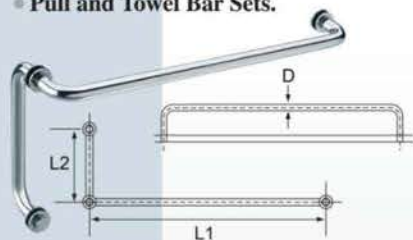

SIZE(mm)

L1(C/C)mm	L2(C/C)mm	D m/m
305(12")	150(6")	19(3/4")
450(18")	200(8")	19(3/4")
600(24")	250(10")	19(3/4")

■ H25SK • Single Side Towel Bar w/Knob.

SIZE(mm)

L	L1(c/c)
500	450



■ H25 • Pull and Towel Bar Sets.

SIZE(mm)

L	L1(c/c)
500	450



Reinforcement Bars

- **No Hole Drilling Required.**
- Complete made of the SUS 304 Stainless Steel.
- For glass thickness 6mm(1/4") to 12mm(1/2")
- Bar supplied in 1200mm(48") stock length Dia.19mm(3/4").
- Available finishes: **PSS**: Polished Stainless Steel.
SSS: Satin Stainless Steel.
TP: Titanium plated. (PVD coated as Gold color).

■ RB 12.1A Wall Mount



■ RB 12.1B Wall Mount



■ RB 12.1C Wall Mount



Ø29mm hole on fixed panel is required.



■ RB 12.2A Glass To Glass



■ RB 12.2B Glass To Glass

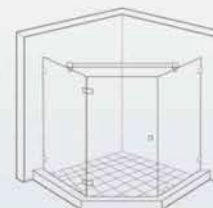

Reinforcement Bars

Accessories

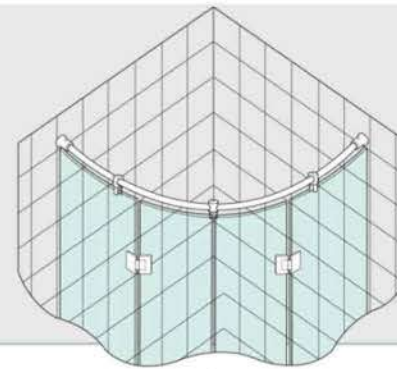

Typical Application

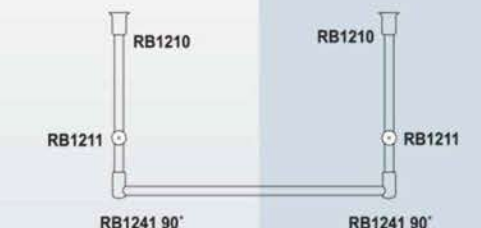
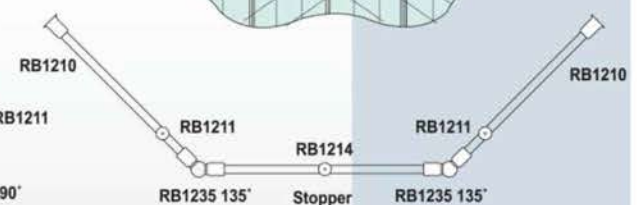
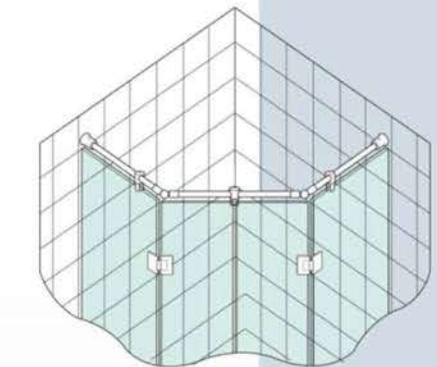
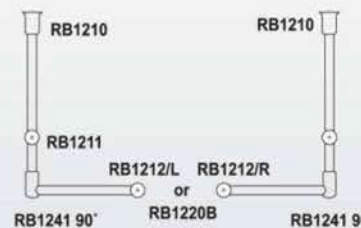
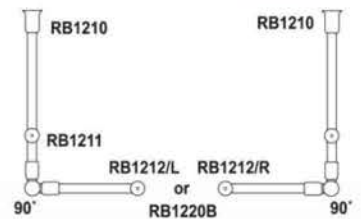
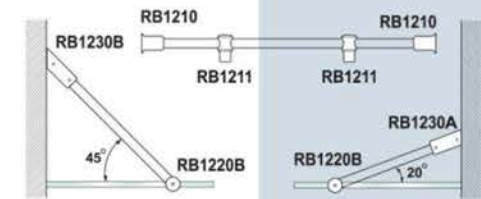
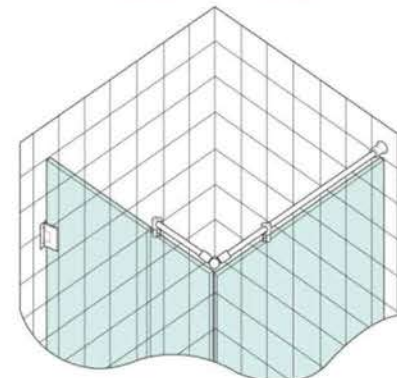

RB 1912 (1200mm)
RB 1930 (3000mm)
(Standard Stock)

* SUS 304 Stainless Steel Tube Dia. 19mm(3/4")
* Any length acceptable by order.

Clear PVC Seals and Wipes

Snap on Tape on types Supplied in 2200mm (87") stock lengths.

Customer length acceptable by order.

"H" Jamb

For 180° Glass to Glass

Code No.	Glass Size
P08 HJ	8mm(5/16")
P10 HJ	10mm(3/8")

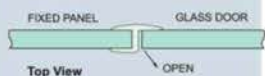
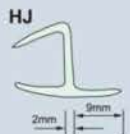

Code No.	Glass Size
P06 HJS	6mm(1/4")
P08 HJS	8mm(5/16")
P10 HJS	10mm(3/8")
P12 HJS	12mm(1/2")

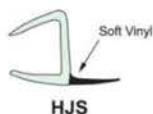

Door Jamb

For 135° Glass to Glass



Code No.	Glass Size
P06 DJ	6mm(1/4")
P08 DJ	8mm(5/16")
P10 DJ	10mm(3/8")

Bottom Rail

Snap on door bottom achieve a seal.
Snap on overlapping bi-fold door as a seal.

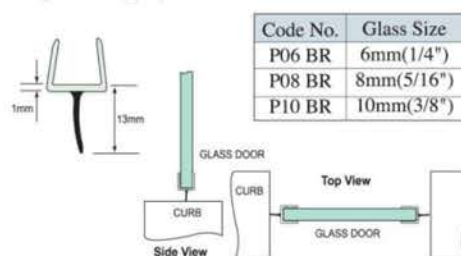

Code No.	Glass Size
P06 BR	6mm(1/4")
P08 BR	8mm(5/16")
P10 BR	10mm(3/8")

Bubble Seal

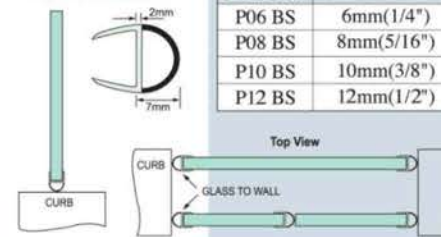

Code No.	Glass Thickness
P06 BS	6mm(1/4")
P08 BS	8mm(5/16")
P10 BS	10mm(3/8")
P12 BS	12mm(1/2")

Snap on door bottom achieve a seal.
Snap on overlapping bi-fold door as a seal.

Strike Jamb

For 90° Glass to Glass

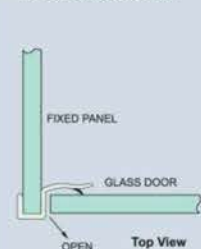

Code No.	Glass Size
P06 SJ	6mm(1/4")
P08 SJ	8mm(5/16")
P10 SJ	10mm(3/8")

Angle Jamb

For Glass to Glass or Glass to Wall

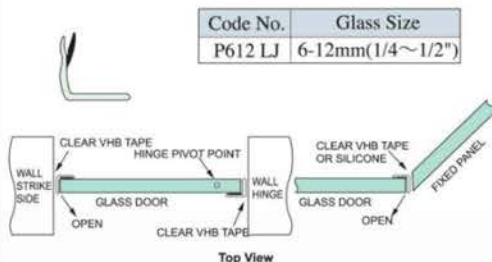

Code No.	Glass Size
P612 LJ	6-12mm(1/4~1/2")

MAGNETIC PROFILES(SEALS)

For both 8mm(5/16") and 10mm(3/8") thick glass.
For frameless glass to close more tightly.
Made of co-extruded material with soft magnetic receiver.
8mm & 10mm glass are in different clearance.

Side Jamb

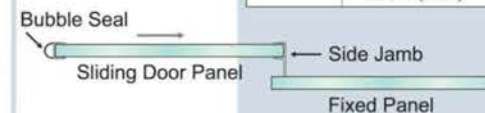

Code No.	Glass Thickness
P810 SDJ	8mm(5/16") 10mm(3/8")

Seal and Wipe

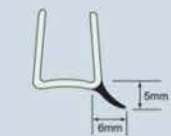

Snap on door bottom as a wipe.
Snap on overlapping bi-fold door as a seal.

Code No.	Glass Size
P06 SW	6mm(1/4")
P08 SW	8mm(5/16")
P10 SW	10mm(3/8")

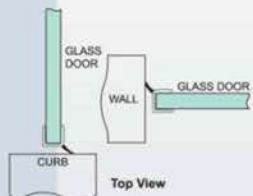

Bottom Wipe with Drip Rail

Soft wipes for create a water tight seal.
45° Drip Rail sheds water back into the shower stall.



Code No.	Glass Size
P06 WDR	6mm(1/4")
P08 WDR	8mm(5/16")
P10 WDR	10mm(3/8")

PG 10A & PG 10B

180° glass to glass use PG 10A or PG 10B reverse for polarity.
Length: 2.2M per length.

PG 10A & PG 10B

90° glass to glass (reverse for polarity)
Length: 2.2M per length.

PG 10D & PG 10E

135° glass to glass.
Length: 2.2M per length.

TH - 01 Shower Door Threshold

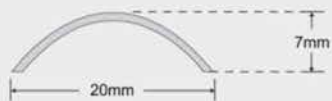

- Made by Stainless Steel SUS304 and Mirror polished.(PSS) (standard stock).
- Length:1000mm per length (standard stock). (Other length available by order).



Indicator Locks & Keepers

- Lock with SUS 304 Stainless Steel Knobs & Covers.
- Coin Open From Outdoor for Emergency.
- Suitable for Glass Door Panel Thickness:8, 10, 12mm.
- Available Finishes: PSS: Polished Stainless Steel.
SSS: Satin Stainless Steel.
TP : Titanium plated.
(PVD coated as Gold color.)

Germany, Taiwan Patented U.S.A. Patent Pending

Notches

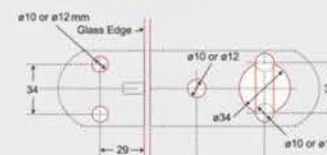

IDL-52K IDL-52
IDL-52LK IDL-52L

DS - 01 Door Stopper

- Made by Solid Stainless Steel SUS304 With black rubber.
- Finish: PSS: Mirror polished.
SSS: Satin (Hairline) polished.
- Fixing screw & anchor are included.

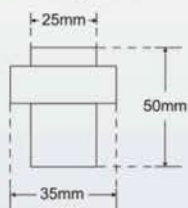

KP-52 Keeper Plate



For keeping and stopping single action door panel (IDL-52).

Material: SUS 304 Stainless Steel.
Finish: PSS: Mirror polished.
SSS: Satin (Hairline) polished.

Single Action type-swing indoor.

IDL - 52

IDL - 52K

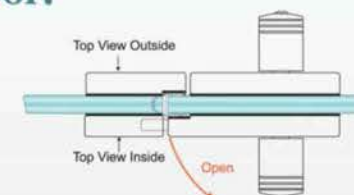

Outdoor



Indoor

Red (Locked) Green (Unlock)

Double Action type-swing indoor or outdoor.

IDL-52L

IDL-52LK

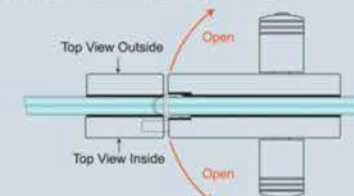

Outdoor



Indoor

Red (Locked) Green (Unlock)

U Channel-For Fixed Panel

- Material: Stainless Steel SUS 304 (Standard stock) or SUS 316 (by order).

Available Finishes: PSS:Polished Stainless Steel.
SSS:Satin Stainless Steel.
TP:Titanium plated.(PVD coated as Gold color).



Unit:mm

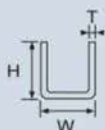

Code No.	W	H	T	L	Code No.	W	H	T	L
U-142020	14	20	2	2200	U-172515	17	25	1.5	3000
U-132015	13	20	1.5	2200	U-172512	17	25	1.2	2400
U-172020	17	20	2	2200	U-172512	17	25	1.2	3000
U-162015	16	20	1.5	2200	U-172012	17	20	1.2	2400
U-171815	17	18	1.5	3000	U-172012	17	20	1.2	3000

- * Thickness, Length & Size are acceptable by order
- * Ø 6mm hole for screw fixing available by order.

GCC®

G-Tech Frameless Door Systems

GX 512 Series

- This series are non-spring hinges and are made of SUS 304 stainless steel. (SUS 316 Stainless Steel available by order).
- **GX 512 Hinges are non-spring and single action design, for proper usage, suggest to use with GX 62MH Series or Magnetic Seal (see page 18) to catch and stop door panel in the center.**
- Prepared for 8mm, 10mm & 12mm thick. glass.
- Max. door weight: 50Kgs (110Lbs) per pair recommend 3 hinges for door weight over 50Kgs.
- Max. door width: 1000mm
- Finish: SSS(Hairline Polished)

GX 62 Series

- Connector-for fixed panel.

GX 62 MH Series

- This series are door stops with concealed magnetic inside to catch door panel.



For detail technical information, please refer to **GCC** G-Tech Frameless Door System Catalogue.



GX 512.1 Glass to Wall Hinge U.S.A. TAIWAN PATENTED.

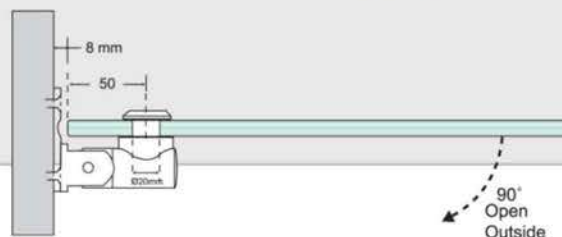

GX 512.1



GX 512.1S

GX 512.2 180° Glass to Glass Hinge U.S.A. TAIWAN PATENTED.

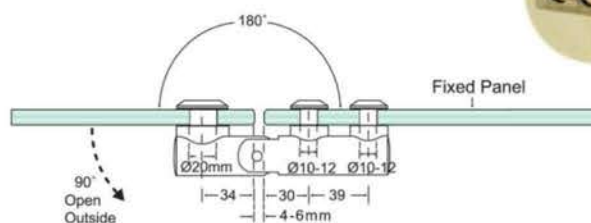

GX 512.2

GX 512.3 135° Glass to Glass Hinge U.S.A. TAIWAN PATENTED.

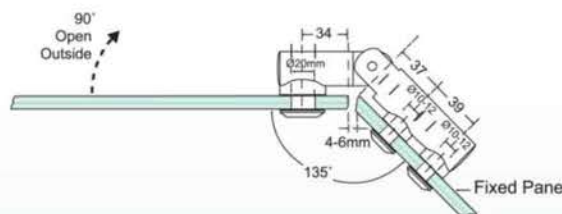

GX 512.3

GX 512.4 90° Glass to Glass Hinge U.S.A. TAIWAN PATENTED.

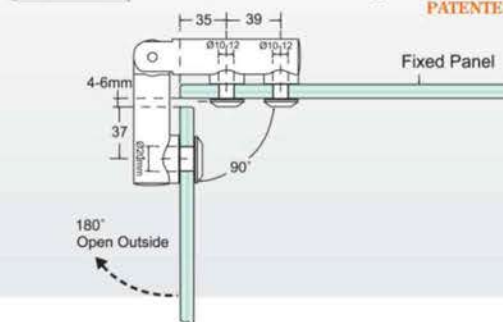

GX 512.4